



REV.	ECN NO.	REVISED	DATE

NOTE:
 1.MATERIAL:
 a.HOUSING:PPA
 b.CONTACT:C5191 OR BeCu (SURFACE PLATING:
 Ni100U"~120U"")
 SEE ORDERING INFORMATION
 2.ELECTRIC:
 a.CONTACT RESISTANCE: 30 MILLIOHMS MAX
 b.INSULATION RESISTANCE: 1000 MEGA OHMS MIN
 c.DIELECTNIC VOLTAGE: 500V AC ONE SEC LEVEL
 d.OPERATING TEMPERATURE: -25°C~ +85°C

ORDERING INFORMATION

BS-05-A***016

PLATING:
 A-Au1U"
 J-Ni100U"~120U"
 K-Sn100U"~120U"
 MATERIAL:
 1A-PBT BLACK
 1B-PA66 BLACK
 2A-PPA BROWN
 2B-PPA BLACK
 3A-PPS BROWN
 3B-PPS BLACK
 4A-LCP WHITE
 4B-LCP BLACK

电池座系列
 BS-05系列
 DIP 90° TYPE

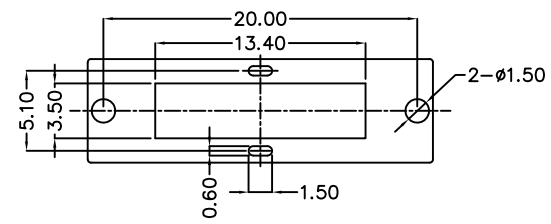
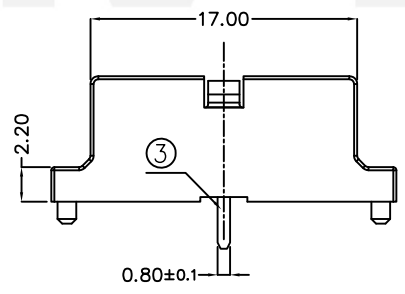
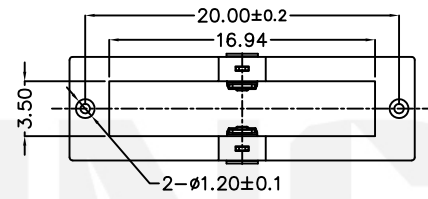
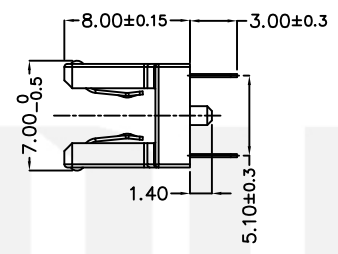
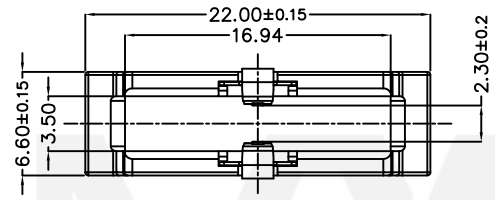
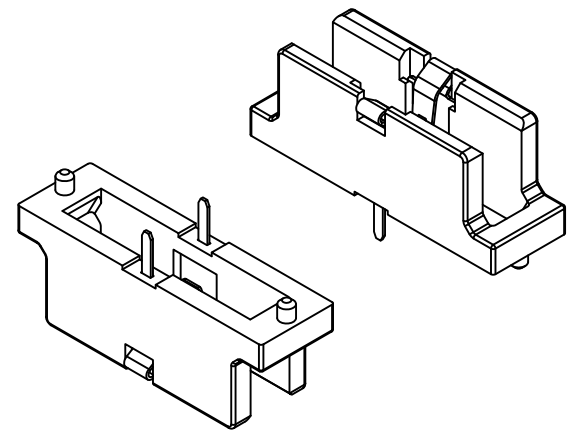
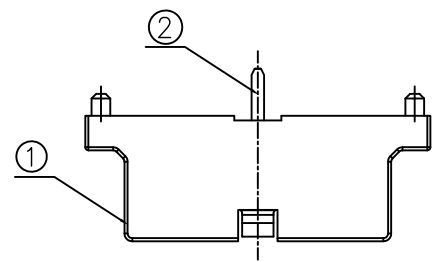

PCB Layout Diagram
 BOTTOM View

工程部
 2018-10-13
 LQ. HUANG

NO.	PART NAME	Q'TY	MATERIAL	PLATING & COLOR
3	TERMINAL(-)	1	C5191 OR BeCu T=0.2	Ni-plating
2	TERMINAL(+)	1	C5191 OR BeCu T=0.2	Ni-plating
1	HOUSING	1	PPA	BLACK

UNLESS OTHERWISE SPECIFIED TOLERANCES		MYOUNG 美阳 www.meiyangdz.com	
DECIMALS: X :±0.30 X.X :±0.25 X.XX :±0.20 X.XXX :±0.10	ANGLES: X :±1° X.X :±0.5°	DSND YangFeng	DATE 2018-06-27
WEIGHT:		CHKD ZhouRuicai	DATE 2018-06-27
SHEET 1 OF 1		APVD XueShunyong	DATE 2018-06-27
TITLE:		SCALE:	VIEW:
PART NO.:		SIZE: A4	REV.: A/0
DRAW NO.:MY-CP-0140		UNIT: mm	OBJECT: MY